

ZANUSSI

 **Electrolux**

WASHING MACHINE

ZWF 1111 W

ZWF 1311 W

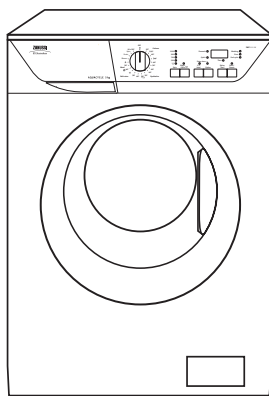

 Quick Installation Guide:

visit our WEB SITE to view an install video

www.video.uk.electrolux.com



Important Safety Information

It is most important that this instruction book should be retained with the appliance for future reference. Should the appliance be sold or transferred to another owner, or should you move house and leave the appliance, always ensure that the book is supplied with the appliance in order that the new owner can get to know the functioning of the appliance and the relevant warnings.

These warnings have been provided in the interest of safety. You **MUST** read them carefully before installing or using the appliance.

Installation

- This appliance is heavy. Care should be taken when moving it.
- It is dangerous to alter the specifications or attempt to modify this product in any way.
- All packing and transit bolts must be removed before use. Serious damage can occur to the product and to property if this is not adhered to. See relevant section in instructions.
- Any plumbing work required to install this appliance should be carried out by a qualified plumber or competent person.
- Any electrical work required to install this appliance should be carried out by a qualified electrician or competent person.
- Care must be taken to ensure that the appliance does not stand on the electrical supply cable.
- If the machine is situated on a carpeted floor, please adjust the feet in order to allow air to circulate freely.
- Always be sure, that there is no water leakage from hoses and their connections after the installation.
- Do not overload the appliance. See relevant section in the instruction book.
- Only wash fabrics which are designed to be machine washed. If in doubt, consult the care label on the clothes.
- Before washing, ensure that all pockets are empty and buttons and zips are fastened. Avoid washing frayed or torn articles and treat stains such as paint, ink, rust, and grass before washing. Underwired bras must NOT be machine washed.
- Any objects such as coins, safety pins, nails, screws, stones or any other hard, sharp material can cause extensive damage and must not be placed into the machine.
- Garments which have been in contact with volatile petroleum products should not be machine washed. If volatile cleaning fluids are used, care should be taken to ensure that the fluid is removed from the garment before placing in the machine.
- Wash small items such as socks, laces, washable belts etc in a washing bag or pillow case as it is possible for such items to slip down between the tub and the inner drum.

Child Safety

- This appliance is designed to be operated by adults. Children should not be allowed to tamper with the controls or play with the product.
- Pets and children have been known to climb into washing machines. Please check your drum before use.
- The glass door becomes very hot during the washing cycle. Keep children away from the vicinity of the appliance whilst it is in operation.
- Keep all packaging well away from children.
- Keep all detergents in a safe place out of children's reach.
- Only use the advised quantities of fabric softener. Damage to the fabric can ensue if you over-fill. Refer to the manufacturer's recommendations of quantities.
- As some duvets and eiderdowns should be washed in large commercial machines because of their bulk, please check with the manufacturer of the item before washing in a domestic machine.
- Leave the porthole door slightly ajar between washes to preserve the door seal.
- Under no circumstances should you attempt to repair the machine yourself. Repairs carried out by inexperienced persons may cause injury or serious malfunctioning. Contact your local Service Force Centre. Always insist on genuine spare parts.

Use

- Always unplug the appliance and turn off the water supply after use.

Contents

| | | | |
|---|-------|------------------------------------|-------|
| For the User | | | |
| Important Safety Information | 2 | | |
| Your New Washing Machine | 4 | | |
| Description of the Appliance | 5 | | |
| Detergent dispenser drawer | 5 | | |
| Child safety feature | 5 | | |
| The Control Panel | 6-9 | | |
| Operating Sequence | 10-11 | | |
| Load the laundry | 10 | | |
| Measure out the detergent | 10 | | |
| Measure out the fabric softener | 10 | | |
| Switch the machine on and select the desired programme/fabric | 10 | | |
| Select the spin speed or the Rinse Hold option | 10 | | |
| Select the desired options | 10 | | |
| Start the programme | 11 | | |
| How to change a programme during its cycle | 11 | | |
| How to cancel a programme during its cycle | 11 | | |
| How to open the door during the cycle of a programme | 11 | | |
| End of programme | 11 | | |
| Washing Hints | 12 | | |
| Which detergent?.... | 13 | | |
| And in which form? | 13 | | |
| Wash Care Symbols | 14 | | |
| Washing Programmes | 15-16 | | |
| | | Maintenance and Cleaning | 17-19 |
| | | Descaling | 16 |
| | | After each wash | 16 |
| | | Maintenance Wash | 16 |
| | | External cleaning | 16 |
| | | Cleaning the dispenser drawer | 16 |
| | | Cleaning the drawer recess | 16 |
| | | Cleaning the pump | 16-17 |
| | | Cleaning the water inlet filter | 18 |
| | | The dangers of freezing | 18 |
| | | Emergency emptying out | 19 |
| | | Something Not Working | 20-21 |
| | | Service and Spare Parts | 21-22 |
| | | Guarantee Conditions | 22 |
| | | For the Installer | |
| | | Installation Instructions | 23-27 |
| | | Technical Specifications | 23 |
| | | Unpacking | 24 |
| | | Positioning | 24 |
| | | Installation on a suspended floor | 24 |
| | | Water inlet | 25 |
| | | Water drainage | 25-26 |
| | | Levelling | 26 |
| | | Special conditions | 26 |
| | | In the interest of the environment | 26-27 |
| | | Electrical connection | 27 |
| | | Permanent connection | 27 |

Guide to use the Instruction Book

The following symbols will be found in the text to guide you throughout the instructions:



Safety instructions



Hints and tips



Environmental information

Your New Washing Machine

Your new washing machine meets all modern requirements for effective treatment of laundry with low water, energy and detergent consumption.

Even small loads are washed “economically” because the amount of water used is regulated automatically according to the load and type of fabric.

- **Automatic cooling of the wash water to 60°C** before draining, with the 95°C programme. This reduces thermal shock to fabrics, helping to prevent creasing.
- **The special wool programme** with its new delicate wash system treats your woollens with extreme care.
- **The balance control device** ensures that the washing machine remains stable when spinning.

Ecological hints

To save water and energy and help protect the environment, we recommend that you follow these hints:

- Normally soiled laundry may be washed without prewashing in order to save detergent, water and time (the environment is protected too!).
- The machine works more economically if it is fully loaded.
- With adequate pre-treatment, stains and limited soiling can be removed; the laundry can then be washed at a lower temperature.
- Measure out detergent according to the water hardness, the degree of soiling and the quantity of laundry being washed.

In the interest of the environment

- Materials marked with the symbol  are recyclable.
- Check with your local Council or Environmental Health Office to see if there are facilities in your area for re-cycling this appliance.
- When the appliance is to be scrapped, cut off the power supply cable and make the door lock device unusable to prevent young children from being trapped inside.
- Help to keep your country tidy - use authorised disposal sites for your old appliance.

The symbol  on the product or on its packaging indicates that this product may not be treated as household waste. Instead it shall be handed over to the applicable collection point for the recycling of electrical and electronic equipment. By ensuring this product is disposed of correctly, you will help prevent potential negative consequences for the environment and human health, which could otherwise be caused by inappropriate waste handling of this product. For more detailed information about recycling of this product, please contact your local city office, your household waste disposal service or the shop where you purchased the product.

**How do we help to protect the environment?
We use recycled paper!**

Important

Your machine is fitted with a balance control device, which ensures the machine is stable during the spin. If the wash load appears not to have been spun sufficiently at the end of the wash cycle, because it is not evenly distributed in the drum, the balance control device may have operated. It will therefore be necessary to redistribute the wash load manually and select a spin programme. For more detailed information see the section headed “Something Not Working”.

Description of the Appliance

This new machine meets all modern requirements for effective treatment of laundry with low water, energy and detergent consumption.

- **The possibility** of selecting the programme/temperature and all the options offered by this washing machine gives you truly “customised” washing.
- The **automatic cooling of the washing water** from 95° to 60°C before draining reduces thermal shock to fabrics, helping to prevent creasing.
- **The ECO valve** allows total use of detergent and reduces water consumption so saving energy.
- **The balance control device** prevents vibration during spinning.

- 1 Detergent dispenser drawer
- 2 Control panel
- 3 Door opening handle
- 4 Drain pump
- 5 Adjustable feet

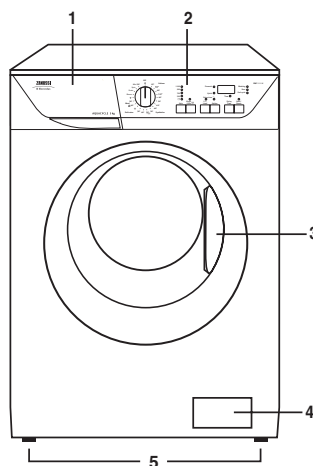

Detergent dispenser drawer



Prewash



Main wash



Fabric softener

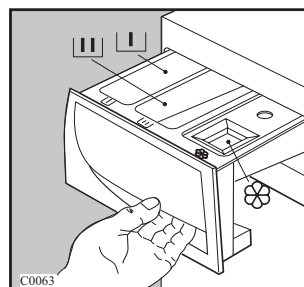

Child safety feature

This machine incorporates a special child safety feature to prevent small children from being trapped inside the machine.

To activate this device, rotate the button (without pressing it) inside the door clockwise until the groove is horizontal. If necessary use a coin.

To disable this device and restore the possibility of closing the door, rotate the button anti-clockwise until the groove is vertical.

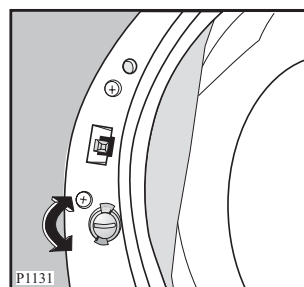

The Control Panel

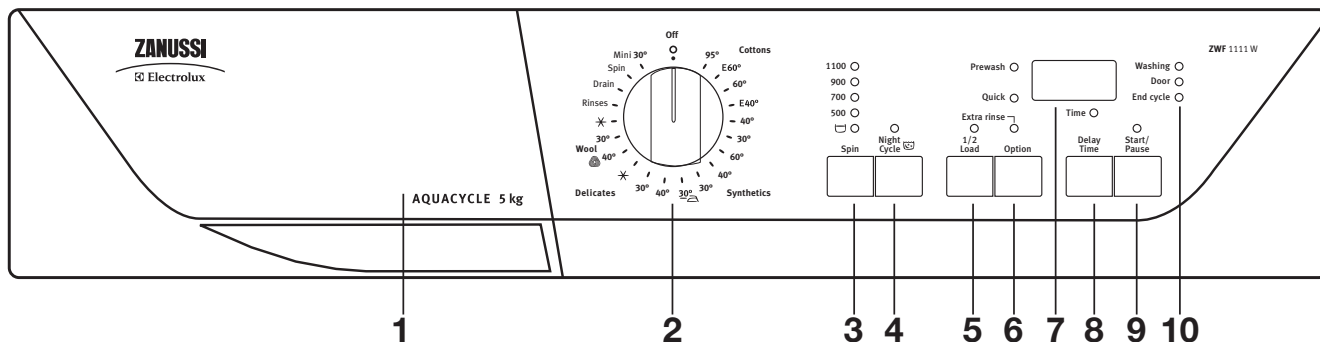

1 Detergent dispenser drawer

2 Programme selector dial

The selector dial is divided into the following sections:

- **Cottons** (blue colour),
- **Synthetics** (green colour)
- **Delicates** (gray colour)
- **Wool** (Handwash) (gray colour)
- **Rinses, Drain, Spin and Mini 30°** (green colour)
- **“O” Off** = Reset/Switching the machine off

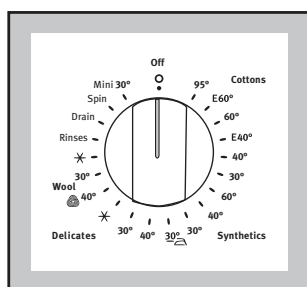

The selector dial can be turned either clockwise or anticlockwise.

E- position corresponds to the ENERGY SAVING programme for cotton and synthetics and position **“O”** **Off** to Reset programme/Switching off of the machine. ***** corresponds to a cold wash

At the end of the programme the selector dial must be always turned to position **“O” Off**, to switch the machine off.

Attention!

If you turn the programme selector dial to another programme when the machine is working, the warning **«Err»** message appears for 3 seconds on the display while the buzzer sounds 3 times.

i IMPORTANT!

By pressing the **Half Load** and **Start Pause** buttons simultaneously for about 3 seconds, the acoustic signal is deactivated at the end of the cycle, when selecting the programmes and in case of an incorrect option selection.

By pressing these 2 buttons again the acoustic signal is reactivated.

3 “Spin” button

Press this button repeatedly to change the spin speed, if you want your laundry to be spun at a speed different from the one proposed by the washing machine or to choose the **☒** **“Rinse Hold”** option. The relevant light will light up.

Maximum speeds for the different models are:

- for cottons: 1100 rpm for ZWF 1111 W and 1300 rpm for ZWF 1311 W
- for synthetics fabrics and Wool: 900 rpm;
- for delicate fabrics and **Mini 30°**: 700 rpm.

“Rinse Hold” position: when you choose this option, the machine will not drain the water of the last rinse, so as not to crease the laundry.

At the end of the cycle, the light of the **“Start/Pause”** button goes out, the **“End cycle”** light illuminates and the **“Door”** light stays on (the door is locked) to indicate that the water must be drained. A flashing zero appears on the display.

To complete the cycle, there are 2 possibilities for emptying out water:

- Select programme **“Drain”**: the water is emptied out without spinning.

- Select programme “Spin”. Select the spin speed by means of the relevant button and then depress the **Start/Pause** button. The water is emptied out and the laundry is spun at the selected spin speed.

Attention! Before selecting the “Drain” or the “Spin” programmes, the selector dial must to be turned to the “O” Off position.

4 “Night Cycle” button

When you choose this option, the machine will not drain the water of the last rinse, so as not to crease the laundry. As all spinning phases are suppressed, this washing cycle is very quiet and it can be useful at night or in times with a more economical power rate.

On cotton and synthetic programmes the rinses will be performed with more water.

At the end of the cycle, the door is locked, the light of the “Start/Pause” button goes out, the “End cycle” light illuminates, the light of “Night Cycle”  button and the “Door” light remain lit to indicate that the water must be drained and a flashing zero will appear on the display.

To complete the cycle, there are 2 possibilities for emptying out water:

- Select programme “Drain”: the water is emptied out without spinning.
- Select programme “Spin”. Select the spin speed by means of the relevant button and then depress the **Start/Pause** button. The water is emptied out and the laundry is spun at the selected spin speed.

Attention! Before selecting the “Drain” or the “Spin” programmes, the selector dial must to be turned to the “O” Off position.

5 “1/2 Load” button

Select this option to reduce water consumption on the rinse cycle when washing ONLY a smaller load of **cottons or linens** (maximum load size = 2,5 kg). The machine perform 2 rinses instead of 3.

6 “Option” button

Press this button to select the following options:

- **Prewash:** select this option if you wish your laundry to be prewashed before the main wash (**not available for Wool and Mini 30° programmes**).

The prewash ends with a short spin in programmes for cotton and synthetic fabrics, whereas in the programme for delicate fabrics the water is only drained.

- **Quick:** select this option for laundry that is only slightly soiled (**not available for Wool, Mini 30° and E-programmes**). The washing time will be reduced according to the type of fabric and the selected temperature.
- **Extra rinse:** This option can be selected with all programmes, except the **wool programmes** and **Mini 30°**. The machine will add 2 rinses to the selected programme. This option is recommended for people who are allergic to detergents, and areas where the water is very soft.

The **Prewash**, the **Quick** and the **Extra rinse** options **cannot** be selected together by means of the relevant button.



7 Display

The following pieces of information are shown on the display:

- **Duration of washing programme** in hours and minutes, after you have selected a programme.



While the programme is running (after you have pressed the “Start/Pause” button), the displayed time value decreases by one unit every minute.

- **The washing machine has stopped with water in the tub**, at the end of a programme with the  “Rinse Hold” or “Night Cycle”  option: this is indicated by a **flashing zero**. The “Door” light will be lit and the door will be locked.
- **The washing machine has completed the programme:** this is indicated by a **flashing zero**. The zero will reappear when you switch the washing machine on, unless the previous programme has been erased by turning the programme selector dial to the “O” Off position. The “Door” light will be off and the door can be opened.

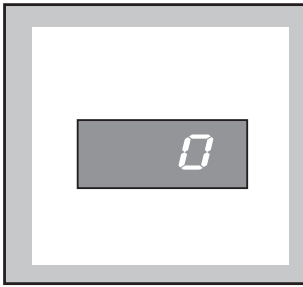

Important!

The first time you use the washing machine, when you switch it on, it may display a flashing zero and give an audible warning signal. This is due to the fact that the washing machine has performed a washing cycle during the manufacturer's inspection tests, and this cycle has not been erased after its completion.

- **Delay start**, a time value indicated in hours and selected by means of the relevant button (max 23 hours).

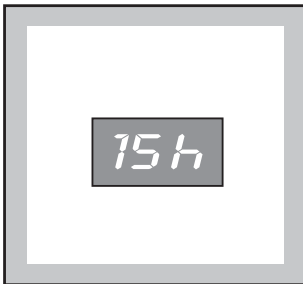

The delay time is displayed for 3 seconds, then the duration of the selected programme reappears. After you have pressed the **“Start/Pause”** button, the countdown begins, and the delay time value decreases by one unit every hour and then, when 2 hours remain, the time decreases in 30 minute intervals. You can delay the start of the selected programme by up to 23 hours in one hour intervals.

- **An incorrect option selection has been made:** this is indicated by the message **Err** when a function incompatible with the current programme is selected.

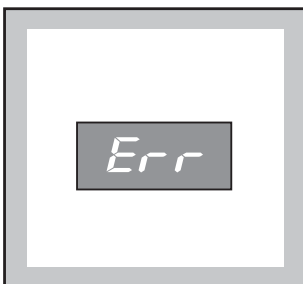

The incorrect selection is also indicated by an audible warning signal.

- **An alarm code** indicates a fault in the machine operation (see the relevant chapter on page 20).

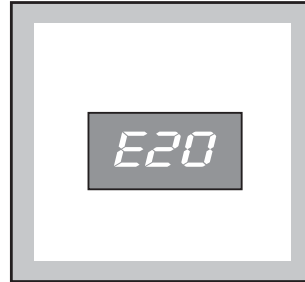

8 “Delay Time” button

This button makes it possible to delay the starting of the programme selected from 30 min - 60 min - 90 min, 2 hours and then by 1 hour up to a maximum of 23 hours. The delay you have selected is shown on the display for about 3 seconds; afterwards, the duration of the programme reappears.

You must select this option **after** you have set the programme and **before** you press the **“Start/Pause”** button.

The time value shown on the display will decrease by one unit every hour.

You can change the delay time at any moment, before you press the **Start/Pause** button.

If you have already pressed the **Start/Pause** button, and you wish to **cancel** the delay time, proceed as follows:

- set the washing machine to Pause by pressing the **“Start/Pause”** button;
- press the **“Delay Time”** button until the display shows the symbol «**U**».
- press the **“Start/Pause”** button again.

Important!

The door will be locked throughout the delay time (the **“Door”** light will be on).

If you need to open the door, you must first set the washing machine to Pause by pressing the **“Start/Pause”** button. The **“Door”** light goes off and the door can be opened.

After you have closed the door, press the **“Start/Pause”** button again.

8 “Start/Pause” button

This button has two functions:

- **Start:** after you have selected the desired programme and options, press this button to start the washing machine. The light above the button will stop flashing and remain lit.
- **Pause:** when you press this button again, the programme in progress is interrupted. The light above the button will start flashing. To restart the programme, press the button again.

Important! You must set the washing machine to **Pause** before you make any change in the programme in progress.

10 Programme phase indicator lights

When you select a programme, all the pilot lights are off.

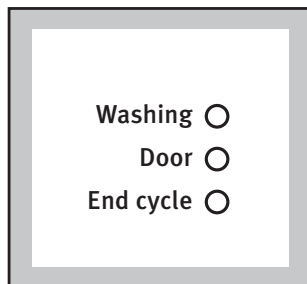

After you have started the programme, the “**Washing**” and the “**Door**” lights illuminate and will remain lit.

At the end of the programme, the “**Washing**” light goes off, the “**End cycle**” light illuminates and the “**Door**” light goes off. It will be possible to open the door.

When the “**Door**” light is on, the door is locked and is not possible to open it.

i Operating Sequence

Before the first wash we recommend that you pour 2 litres of water into the main wash compartment  of the detergent drawer in order to activate the ECO valve. Then run a cotton cycle at 95°C, with the machine empty, in order to remove any manufacturing residue from the drum and tub. Pour half a measure of detergent into the main wash compartment and start up the machine.

1. Load the laundry

Open the door.

Place the laundry in the drum, one item at a time, shaking them out as much as possible.

Close the door.

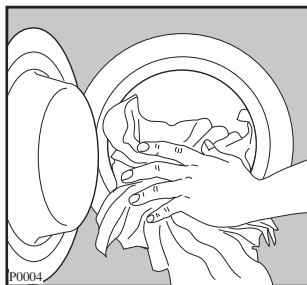

2. Measure out the detergent

Pull out the dispenser drawer until it stops. Measure out the amount of detergent required and pour it into the main wash compartment .

If you wish to carry out the prewash, pour detergent into the appropriate compartment marked .

3. Measure out the fabric softener

If required, pour fabric softener into the compartment marked , **without exceeding the «MAX» mark.**

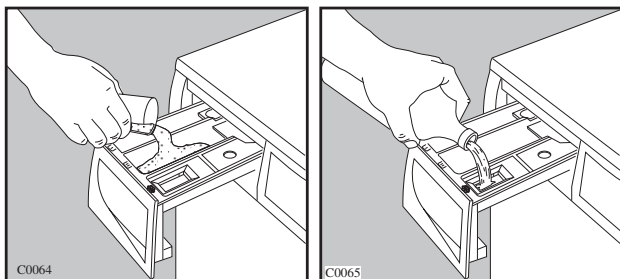

Close the drawer gently.

4. Switch the machine on and select the desired programme

Turn the selector dial to the desired programme to switch the appliance on. The display will show the duration of the selected programme.

To switch the appliance off turn it to “O” Off position. The “Start/Pause” button light will start flashing.

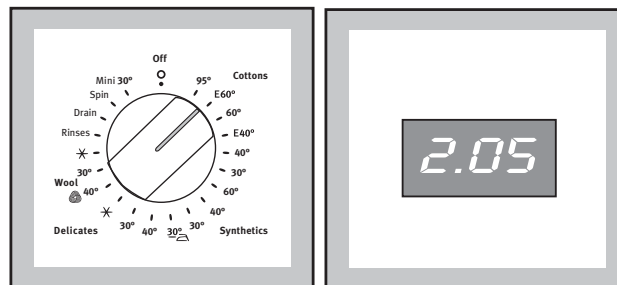

5. Select the spin speed or the RINSE HOLD option

Press the “Spin” button repeatedly, in order to select the desired spin speed or the  “Rinse Hold” option. The relevant light will light up.

If you select the  “Rinse Hold” option, the machine will stop at the end of the programme with the water still in the tub.

ZWF 1111 W

ZWF 1311 W

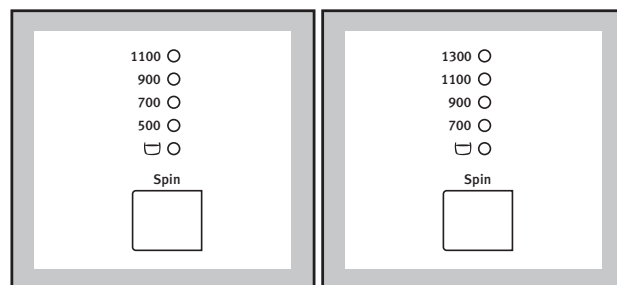

6. Select the desired options

Depress the relevant buttons to select the required options. The corresponding light illuminates.

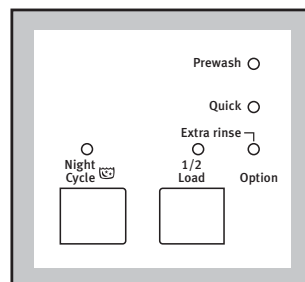

If you select the “**Night Cycle**”  option, the machine will stop at the end of the programme with the water still in the tub.

7. Start the programme

Press the “**Start/Pause**” button. The relevant light will stop flashing and the “**Washing**” and “**Door**” pilot lights illuminate and will remain lit.

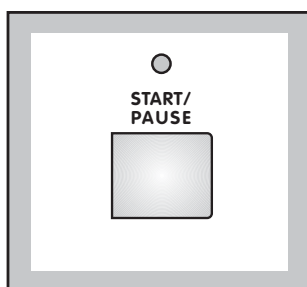

8. How to change an option or a programme during its cycle

If the programme has already started, before you make any change, you must pause the washing machine by pressing the **Start/Pause** button.

It is possible to change any option before the programme carries it out.

Changing a running programme is possible only by cancelling it and selecting a new programme. Turn the programme selector dial to “**O**” **Off** position and then to the new programme position. Start the new programme by depressing the **Start/Pause** button. The washing water remains in the tub.

Note: To drain the water before starting the new cycle you have to cancel the programme and select the **Drain** programme.

9. How to cancel a programme during its cycle

Turn the selector dial to “**O**” **Off** position to cancel a programme which is running. Now you can select a new programme.

10. How to open the door during the cycle of a programme

You can open the door, after having set the washing machine to PAUSE, provided the following conditions exist:

- the washing machine is not in the heating phase beyond 55°C;

- the level of the water is not high;

If these requirements are met, when you pause the washing machine, the “**Door**” pilot light goes off and the door can be opened.

Should it not be possible to open the door (“**Door**” pilot light on), and should it be absolutely necessary to do so, switch the machine off by turning the selector dial on **Off** position.

After approximately 3 minutes, you can open the door.



Pay attention to the level and temperature of the water in the washing machine!

After closing the door, select the programme again and depress the **Start/Pause** button.

11. End of programme

At the end of the programme, the washing machine stops automatically and gives an audible signal.

The light of the “**Start/Pause**” button, the “**Door**” and “**Washing**” pilot lights go off and the light “**End cycle**” illuminates. The display will show a flashing zero.

If you had selected the  “**Rinse Hold**” or the “**Night Cycle**”  option, the corresponding button lights will be on, the display will show a flashing zero but the “**Door**” pilot light will stay on to indicate that the door is locked and the water must be drained.

To complete the cycle, there are 2 possibilities for emptying out water:

- turn the selector dial to the “**O**” **Off** position and then select programme “**Drain**”: the water is emptied out without spinning.

or

- turn the selector dial to the “**O**” **Off** position and then select programme “**Spin**”. Select the spin speed by means of the relevant button and then depress the **Start/Pause** button. The water is emptied out and the laundry is spun at the selected spin speed.

When the programme has been completed the audible signal is given. Turn the selector dial on **Off** position to switch the machine off. Remove the laundry from the washing machine.

Check whether the drum is completely empty, by rotating it with your hand. The purpose of this is to prevent any items of laundry from remaining accidentally in the drum, where they might get damaged in a subsequent wash (e.g. by shrinking) or bleed colour into another load of laundry.

We advise you to close the water supply tap and disconnect the plug from the socket. Leave the door ajar in order to air the washing machine.

Washing Hints

Do **NOT** overload the machine. Weigh the laundry the first few times you use the appliance.

The average weights of the most common items are listed below as a guide:

1000g = 1 kg

| | |
|----------------------|-------------|
| Sheet | 700-1000 g |
| Pillow case | 100-200 g |
| Tablecloth | 400-500 g |
| Serviette | 50-100 g |
| Tea towel | 70-120 g |
| Linen hand towel | 100-150 g |
| Towelling hand towel | 150-250 g |
| Towelling bath towel | 700-1000 g |
| Bath robe | 1000-1500 g |
| Man's shirt | 200-300 g |
| Apron | 150-200 g |

- Load the laundry loosely alternating large items with small ones.
- Sort the laundry according to the type of fabric, colour-fastness and how dirty it is.
- Avoid washing unhemmed or torn items as they may unravel.
- Before washing, empty all pockets of small objects which may have been left inside (coins, keys, screws etc). as these could damage the drain pump.
- When washing curtains, remove the hooks.
- Close poppers and zips and fasten loose buttons.
- It is essential to wash new coloured items separately when washing for the first time.
- When washing fabrics requiring different wash temperatures together, always select the lowest temperature.
- White items should not be washed with coloured items.
- Very small items (handkerchiefs, ribbons, socks etc) should be washed in a washing bag or a pillow case.
- Use a good quality detergent suitable for automatic washing machines.
- Use the correct quantities of detergent.
- For wool, use gentle detergent only in small quantities.
- Bleach is very corrosive; it should be used with care and kept out of reach of children.
- Some stains such as fruit, wine, grass, rust etc. are difficult to remove and should be treated before washing with specific products, which can be found in most household shops. In some cases it may help to soak the stain before washing with a special pre-soak product or biological detergent.
- Only wool marked "Pure New Wool - washable, preshrunk" can be washed in the the wool programme; other types of wool should be washed by hands.
- If you have used the machine to wash, rinse or spin only non-colour fast garments, there may be dye left in the sump. To ensure any subsequent wash is not contaminated with the dye, select and carry out a rinse and spin programme, without any garments, to ensure that any dye is removed from the sump.
- Once you have finished using the machine, you are advised to unplug it and turn off the water tap.

Which detergent?....

To ensure you obtain the best wash results from your appliance, it is important to use the right detergent in your everyday wash, and only detergents recommended for use in automatic machines.

To maintain the appearance of your clothes and household textiles and to make them last longer you should use different types of detergent for different washes, whether for whites, colours or delicates.

WHITES

We recommend the Ariel product range which is biological and designed to provide excellent cleaning and stain removal even at low temperatures.



NON BIOLOGICAL

If you prefer to use a non biological detergent, which does not contain enzymes we recommend Fairy. Fairy provides good cleaning and stain removal.



COLOURS

For coloured items you should use a detergent which is designed to clean while maintaining the original colour. Ariel Color does not contain bleach and therefore helps to preserve colours.



DELICATE ITEMS

When washing delicates such as woollens, you should use a product which is specially designed to care for fine fabrics.

Dreft Automatic is suitable for woollens and other delicates.

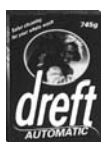

LAUNDRY BLEACH

For additional stain removal you may wish to use a product such as Ace Gentle Bleach which is used in addition to your chosen detergent. Ace is suitable for all washable fabrics including silks, woollens and colours.



And in which form?

Not only are there different types of detergent, but they are also available in different forms. Whether you chose a powder or liquid in traditional or compact form is your own personal choice.

TRADITIONAL POWDERS

Pour the powder directly into the dispenser drawer. Do not sprinkle powder onto clothes in the machine drum.

TRADITIONAL LIQUIDS

Liquid can be placed in the main wash compartment of the detergent drawer marked with the symbol , start the machine immediately upon placing the detergent in the dispenser drawer.

Alternatively the detergent is measured into the specially designed dosing device* which should be placed on top of the laundry, and at the back of the machine drum.

COMPACT POWDERS AND LIQUIDS

Compact detergents (or concentrates as they are also known) are available in liquid or powder form, and generally require a smaller dosage. Follow the manufacturer's instructions to ensure the most economical usage. Pour the detergent directly into the dispenser drawer, or alternatively measure the detergent into the specially designed dosing device* which should be placed on top of the laundry, and at the back of the machine drum.

*** If you use a dosing device in a washer dryer, please ensure the dosing device/ball is removed before carrying out a drying programme.**

FABRIC CONDITIONERS

These are ideal for improving 'softness', and also reduce static cling on synthetics and make ironing easier. They are available in two types:

For example Lenor liquid fabric softener, for use in the **washing machine/washer dryer**. The liquid fabric softener should be poured into the compartment marked with the symbol . Follow the manufacturer's dosage instructions and never exceed the MAX level.



Bounce conditioning sheets for use in a **tumble dryer**. We recommend the conditioning sheets are pinned (using a safety pin) to an article of laundry and placed in the tumble dryer.



Wash Care Symbols

Wash care labels inside garments recommend how to launder your clothes with the best results. The care labelling code is in line with care labelling used in the rest of Europe. The symbols used make it easy to select the correct programme on your washing machine.

| WASHING SYMBOL | WASH ACTION | FABRIC |
|----------------------|--|---|
| | Normal (Maximum) | White Cotton or Linen without Special Finishes |
| | Normal (Maximum) | Cotton, Linen or Viscose without Special Finishes Colourfast at 60°C. |
| | Reduced (Medium) | Nylon, Polyester/Cotton, Viscose with Special Finishes, Cotton/Acrylic Mix. |
| | Normal (Maximum) | Cotton, Linen or Viscose Colourfast at 40°C but not 60°C. |
| | Reduced (Medium) | Acrylics, Acetate, Triacetate, Wool mixes, Polyester/wool blends. |
| | Much Reduced (Minimum) | Wool, wool mixtures, Silks |
| | Hand wash only | Do not machine wash |
| BLEACHING | | |
| | Chlorine bleach may be used | |
| IRONING | | |
| | Hot iron | Cotton, Linen, Viscose |
| | Warm iron | Polyester mixtures, Wool |
| | Cool iron | Acrylic, Nylon, Polyester |
| DRY CLEANING | | |
| | May be dry cleaned. Other letters and/or a bar beneath the circle will indicate the required process to the dry cleaner. | |
| TUMBLE DRYING | | |
| | with high heat setting | |
| | with low heat setting | |
| | May be tumble dried | |
| | A cross through any symbol means «DO NOT» | |



Important Notes

For best results, always use the dispenser drawer for dispensing detergents and liquid additives. Once the dispenser has been filled, close it by pushing it in gently. This is particularly important if you are using

fabric conditioner to avoid the conditioner entering the machine prematurely.

When using liquid detergent and a prewash programme, place the detergent into the correct compartment in the dispenser drawer, after the prewash has finished.

Washing programmes







| Fabrics | Programme/ temperature | Type of laundry | Available options | Load | Consumptions* | |
|--|---|---|---|--------|---------------|--------------|
| | | | | | Energy kWh | Water litres |
| White cotton | 95° Cottons | Sheets, household linen, towels, tablecloths | Spin reduction/☐ Night Cycle ☺ 1/2 Load, Prewash, Quick, Extra rinse | 5 Kg | 2.1 | 57 |
| White cotton or fast colours | E60° Cottons Economy | Sheets, household linen, towels, tablecloths | Spin reduction/☐ Night Cycle ☺ 1/2 Load, Prewash, Extra rinse | 5 Kg | 0.95 | 49 |
| White and coloured cotton | 60° - 40° - 30° Cottons | Fast coloured and non-fast items, for example hand towels, sheets, underwear, tablecloths, shirts | Spin reduction/☐ Night Cycle ☺ 1/2 Load, Prewash, Quick, Extra rinse | 5 Kg | 1.2 | 57 |
| Coloured cotton | E40° Cottons Economy | Coloured items, for example underwear, shirts, blouses | Spin reduction/☐ Night Cycle ☺ 1/2 Load, Prewash, Extra rinse | 5Kg | 1.14 | 49 |
| Synthetics | 60° - 40° - 30° Synthetics | Shirts, blouses, underwear, mixed fabrics | Spin reduction/☐ Night Cycle ☺ Prewash, Quick, Extra rinse | 2,5 Kg | 0.8 | 42 |
| Synthetics | Easy Iron 30° ☺ Synthetics | Shirts, blouses, underwear, mixed fabrics | Spin reduction/☐ Night Cycle ☺ Prewash, Quick, Extra rinse | 2,5 Kg | 0.5 | 52 |
| Delicates | 40° - 30° - ✖ Delicates | Acrylic, viscose, polyester items, curtains | Spin reduction**/☐ Night Cycle ☺ Prewash, Quick, Extra rinse | 2,5 Kg | 0.55 | 57 |
|  Wool  | 40° - 30° - ✖ Wool  | Garments bearing the “Pure new wool, non-shrink, machine washable” or “Hand wash” label | Spin reduction/☐ Night Cycle ☺ | 2 kg | 0.35 | 55 |

The “E60° Cottons” is the reference programme for the data entered in the energy label, in compliance with EEC 92/75 standards.

* This data is given purely as an indication: the consumption values may vary in relation to the quantity and type of laundry, the temperature of the water supply and the ambient temperature. The data refers to the highest temperature provided for each programme.

** The spin reduction is available only in the model **ZWF 1111 W**.

Washing programmes

| Programme | Programme description | Available options | Load | Consumptions* | |
|---|--|---|--------|---------------|--------------|
| | | | | Energy kWh | Water litres |
| Rinses | 3 rinses Long spin at max. speed | Spin reduction /  Night Cycle  Extra rinse | 5 Kg | 0.06 | 59 |
| Drain For emptying out the last rinse of the programmes with “Rinse hold” /  or “Night Cycle”  option | Water draining | - | 5 Kg | - | - |
| Spin | Drain and long spin at max. speed* | Spin reduction | 5 Kg | - | - |
| Mini 30° Short cycle for lightly soiled fabrics | Wash at 30°C 2 rinses Short spin | Spin reduction** /  Night Cycle  | 2.5 Kg | 0.3 | 40 |
| “O” Off / Reset | For cancelling the programme which is running or to switch the machine off | | - | - | - |

* You can reduce the spin speed by means of the relevant button to adapt it to the fabrics to be spun.

** The spin reduction is available only in the model **ZWF 1111 W**.

Maintenance and Cleaning

Before any maintenance or cleaning is carried out you must **DISCONNECT** the appliance from the electricity supply.

Descaling

The water we use normally contains lime. It is a good idea to periodically use a water softening powder in the machine. Do this separately from any laundry washing, and according to the softening powder manufacturer's instructions. This will help to prevent the formation of lime deposits.

After each wash

Leave the door open for a while. This helps to prevent mould and stagnant smells forming inside the appliance. Keeping the door open after a wash will also help to preserve the door seal.

Maintenance Wash

With the use of low temperature washes it is possible to get a build up of residues inside the drum. We recommend that a maintenance wash be performed on a regular basis.

To run a maintenance wash:

- The drum should be empty of laundry.
- Select the hottest cotton wash programme.
- Use a normal measure of detergent, must be a powder (such as Ariel Futur).

External cleaning

Clean the exterior cabinet of the appliance with soap and water only, and then dry thoroughly.

Cleaning the dispenser drawer

The washing powder and additive dispenser drawer should be cleaned regularly.

Remove the drawer by pressing the catch downwards and by pulling it out. Flush it out under a tap, to remove any traces of accumulated powder.

To aid cleaning, the top part of the additive compartment should be removed.

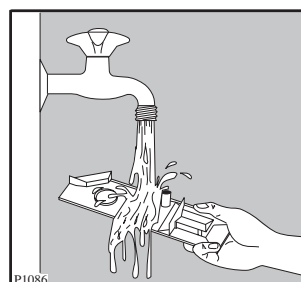
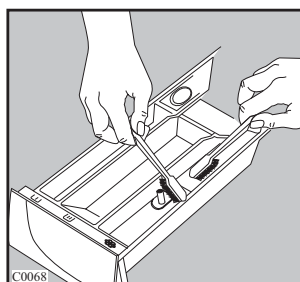
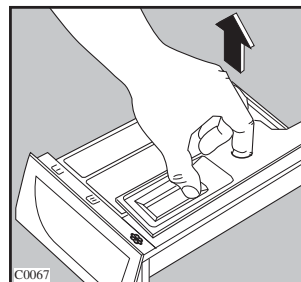
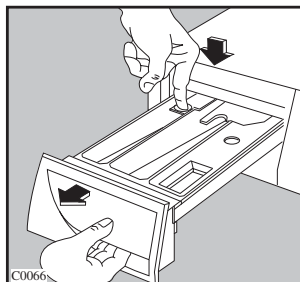

Cleaning the drawer recess

Having removed the drawer, use a small brush to clean the recess, ensuring that all washing powder residue is removed from the upper and lower part of the recess. Replace the drawer and run the rinse programme without any clothes in the drum.

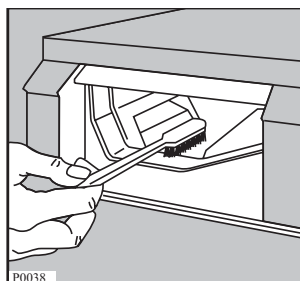

Cleaning the pump

The pump should be inspected if

- the machine does not empty and/or spin
- the machine makes an unusual noise during draining due to objects such as safety pins, coins etc. blocking the pump.

Proceed as follows:

- Disconnect the appliance.
- If necessary wait until the water has cooled down.
- Open the pump door.

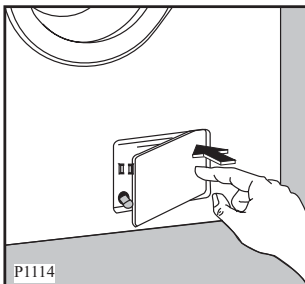

- Place a container close to the pump to collect any spillage.
- Pull out the emergency emptying hose, place it in the container and remove its cap.
- When no more water comes out, unscrew the pump cover and remove it. Always keep a rag nearby to dry up spillage of water when removing the cover.

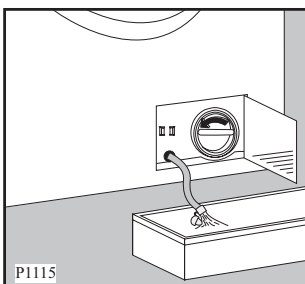

- Remove any objects from the pump impeller by rotating it.

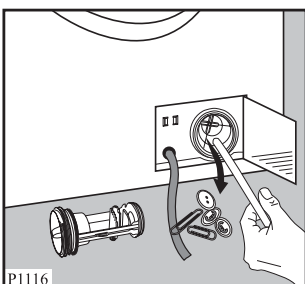

- Put the cap back on the emergency emptying hose and place the latter back in its seat.

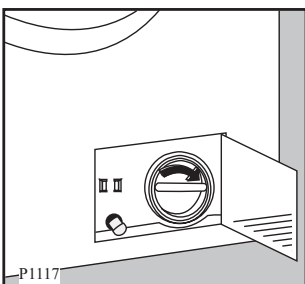

- Screw the pump cover fully in.
- Close the pump door.

Warning

When the appliance is in use and depending on the programme selected there can be hot water in the pump. Never remove the pump cover during a wash cycle, always wait until the appliance has finished the cycle, and is empty. When replacing the cover, ensure it is securely retightened so as to stop leaks and young children being able to remove it.

Cleaning the water inlet filter

If your water is very hard or contains traces of lime deposit, the water inlet filter may become clogged. It is therefore a good idea to clean it from time to time. Turn off the water tap. Unscrew the water inlet hose. Clean the filter using a hard bristle brush. Tighten up the inlet hose.

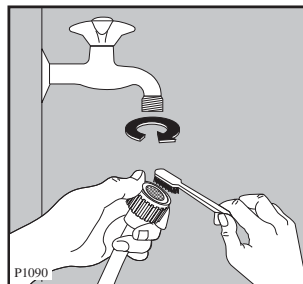

The dangers of freezing

If the machine is installed in a place where the temperature could drop below 0°C, proceed as follows:

- Remove the plug from the socket.
- Close the water tap and unscrew the water inlet hose from the tap.
- Place the end of the emergency emptying hose and that of the inlet hose in a bowl placed on the floor and let water drain out.
- Screw the water inlet hose back on and reposition the emergency emptying hose after having put the cap on again.

By doing this, any water remaining in the machine is removed, avoiding the formation of ice and, consequently, breakage of the affected parts.

When you use the machine again, make sure that the ambient temperature is above 0°C.

Important!

Every time you drain the water through the emergency emptying hose you must pour 2 litres of water into the main wash compartment of the detergent drawer and then run the Drain programme. This will activate the ECO valve and avoid the detergent remains being wasted.

Emergency emptying out

If the water is not discharged, proceed as follows to empty out the machine:

- pull out the plug from the power socket;
- close the water tap;
- if necessary, wait until the water has cooled down;
- open the pump door;
- place a bowl on the floor and place the end of the emergency emptying hose into the bowl. Remove its cap. The water should drain by gravity into the bowl. When the bowl is full, put the cap back on the hose. Empty the bowl. Repeat the procedure until water stops flowing out;
- clean the pump if necessary as previously described;
- replace the emergency emptying hose in its seat after having plugged it;
- screw the pump cover again and close the door.

Something Not Working

Certain problems are due to lack of simple maintenance or oversights, which can be solved easily without calling out an engineer. Before contacting your local Service Force Centre, please carry out the checks listed below.

IMPORTANT: if you call out an engineer to a fault listed below, or to repair a fault caused by incorrect use or installation, a charge will be made even if the appliance is under guarantee.

During machine operation it is possible that one of the following alarm codes appears on the display and at the same time the buzzer sounds:

- **E10** : problem with the water supply
- **E20** : problem with water draining
- **E40** : door open

Once the problem has been eliminated, press the “**Start/Pause**” button to restart the programme. If after all checks, the problem persists, contact your local Service Force Centre.

| Symptom | Possible causes |
|---|---|
| The machine does not start | <ul style="list-style-type: none"> ● The door has not been closed. (E40) ● The plug is not properly inserted in the power socket. ● There is no supply at the socket. ● The main fuse or the fuse in the plug has blown. ● The “Start/Pause” button has not been depressed. ● A delayed start has been selected. |
| The machine does not fill | <ul style="list-style-type: none"> ● The water tap is closed. (E10) ● The filter in the inlet hose is blocked. (E10) ● The inlet hose may be squashed or kinked. (E10) ● The door has not been closed. (E40) |
| The machine fills then empties immediately | <ul style="list-style-type: none"> ● The end of the drain hose is too low. ● The end of the drain hose is submerged in water. ● There is no vent in the end of the drain hose. |
| The machine does not empty and/or does not spin | <ul style="list-style-type: none"> ● The drain hose may be squashed or kinked. (E20) ● The “Rinse Hold” or “Night Cycle” option has been selected. ● The drain pump may be blocked. (E20) ● The drain hose extension, if fitted, is not correct. Follow the instructions for connecting to the waste. ● The drainage system pipes are blocked. ● The wash load is unbalanced: redistribute the clothes inside the drum to allow the machine to spin. |
| There is water on the floor | <ul style="list-style-type: none"> ● Too much detergent or unsuitable detergent has been used (creates too much foam). ● Check whether there are any leaks from the inlet hose fittings. It is not always easy to see this as the water runs down the hose; check to see if it is damp. ● The drain hose may be damaged or not securely positioned. ● The detergent dispenser drawer or recess is clogged. ● The drainage system pipes are blocked. ● The cap on the emergency emptying hose has not been replaced after cleaning the pump. |
| Unsatisfactory washing results | <ul style="list-style-type: none"> ● Too little detergent or unsuitable detergent has been used. An insufficient amount of detergent leaves the laundry looking grey and causes lime scale to form. ● Stubborn stains have not been treated prior to washing ● The correct wash programme/temperature has not been selected. ● Too much laundry has been placed in the drum. |

| Symptom | Possible causes |
|--|---|
| The machine vibrates when spinning | <ul style="list-style-type: none"> • The machine is in contact with the wall or furniture. • The machine is not level and stable (check diagonally). • The washing load is badly distributed in the drum. • Maybe there is very little laundry in the drum. |
| The door will not open | <ul style="list-style-type: none"> • The water level is above the bottom edge of the door. • The machine is heating the water. • The drum is turning. <p>In any case, the door can be opened only when the “Door” pilot light has gone off.</p> |
| Spinning starts late or the machine does not spin | <ul style="list-style-type: none"> • The electronic unbalance detection device has cut in because the laundry is not evenly distributed in the drum. The laundry is redistributed by reverse rotation of the drum. This may happen several times before the unbalance disappears and normal spinning can resume. If, after 10 minutes, the laundry is still not evenly distributed in the drum, the machine will not spin. In this case, redistribute the load manually and select the spin programme. |
| The machine makes an unusual noise | <ul style="list-style-type: none"> • The machine is fitted with a type of motor which makes an unusual noise compared with other traditional motors. This new motor ensures a softer start and more even distribution of the laundry in the drum when spinning, as well as increased stability of the machine. |
| No water is visible in the drum | <ul style="list-style-type: none"> • Machines based on modern technology operate very economically using very little water without affecting performance. |

Service & Spare Parts **SERVICE FORCE**

In the event of your appliance requiring service, or if you wish to purchase spare parts, please contact your local Service Force Centre by telephoning:

0870 5 929929

Your telephone call will be automatically routed to the Service Force Centre covering your post code area.

For the address of your local Service Force Centre and further information about Service Force, please visit the website at www.serviceforce.co.uk.

For Customer Service in Ireland please contact us at the address below:

Zanussi Electrolux - Electrolux Group (Irl) Ltd
Long Mile Road - Dublin 12
Republic of Ireland

Tel: +353 (0)1 4090751

Email: service.eid@electrolux.ie

To buy accessories, consumables and spare parts at our online shop please visit: <http://www.zanussi-electrolux.co.uk>

Before calling out an engineer, please ensure you have read the details under the heading “Something Not Working”.

When you contact the Service Force Centre you will need to give the following details:

1. Your name, address and post code
2. Your telephone number
3. Clear and concise details of fault
4. The model and serial number of the appliance (found on the rating plate - see picture)
5. The purchase date.

Please note that a valid purchase receipt or guarantee documentation is required for in-guarantee service calls.

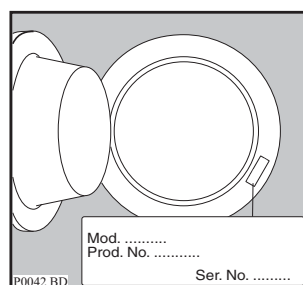

Customer Care Department

For general enquiries concerning your Zanussi Electrolux appliance or for further information on Zanussi Electrolux products, please contact our Customer Care Department by letter or telephone at the address below or visit our website at www.zanussi.co.uk

Customer Care Department - Zanussi Electrolux
Major Appliances - Addington Way
 Luton - Bedfordshire
 LU4 9QQ
 Tel 08705 727727*

* calls to this number may be recorded for training purposes.

Guarantee Conditions

Standard guarantee conditions

We, Zanussi Electrolux, undertake that if, within 12 months of the date of the purchase, this ZANUSSI ELECTROLUX appliance or any part thereof is proved to be defective by reason only of faulty workmanship or materials, we will, at our option repair or replace the same FREE OF ANY CHARGE for labour, materials or carriage on condition that:

- The appliance has been correctly installed and used only on the electricity supply stated on the rating plate.
- The appliance has been used for normal domestic purposes only, and in accordance with the manufacturer's instructions.
- The appliance has not been serviced, maintained, repaired, taken apart or tampered with, by any person not authorised by us.
- All service work under this guarantee must be undertaken by a Service Force Centre.
- Any appliance or defective part replaced shall become the Company's property.
- This guarantee is in addition to your statutory and other legal rights.

Home visits are made between **8.30am** and **5.30pm** Monday to Friday. Visits may be available outside these hours in which case a **premium** will be charged.

Exclusions

This guarantee does not cover:

- Damage or calls resulting from transportation, improper use or neglect, the replacement of any light bulbs or removable parts of glass or plastic.
- Costs incurred for calls to put right an appliance which is improperly installed or calls to appliances outside the United Kingdom.

- Appliances found to be in use within a commercial environment, plus those which are subject to rental agreements.
- Products of Zanussi Electrolux manufacture which are NOT marketed by Zanussi Electrolux.

European guarantee





If you should move to another country within Europe then your guarantee moves with you to your new home subject to the following qualifications:

- The guarantee starts from the date you first purchased your product.
- The guarantee is for the same period and to the same extent for labour and parts as exists in the new country of use for this brand or range of products.
- The guarantee relates to you and cannot be transferred to another user.
- Your new home is within the European Community (EC) or European Free Trade Area.
- The product is installed and used in accordance with our instructions and is only used domestically, i.e. a normal household.
- The product is installed taking into account regulations in your new country.

Before you move please contact your nearest Customer Care Centre, listed below, to give them details of your new home. They will then ensure that the local Service Organisation is aware of your move and able to look after you and your appliances.

| | | |
|---------|-----------|----------------------|
| France | Senlis | +33 (0) 344 62 29 29 |
| Germany | Nurnberg | +49 (0) 800 234 7378 |
| Italy | Pordenone | +39 0434 39 4700 |
| Sweden | Stockholm | +46 (0) 8 672 53 90 |
| UK | Luton | +44(0) 8705 727 727 |
| Ireland | Dublin | +44 (0)1 4090751 |

Installation Instructions

-  It is dangerous to alter the specifications or attempt to modify this product in any way.
-  Care must be taken to ensure that the appliance does not stand on the electrical supply cable.
-  Any electrical work required to install this appliance should be carried out by a qualified electrician or competent person.
-  Any plumbing work required to install this appliance should be carried out by a qualified plumber or competent person.

Technical Specifications

| | | |
|---|---|--|
| DIMENSIONS | Height Width Depth | 85 cm 60 cm 63 cm |
| POWER SUPPLY VOLTAGE TOTAL POWER ABSORBED | | 230-240 V/50 Hz 2050 W (10A) |
| WATER PRESSURE | Minimum Maximum | 0.05 MPa (0.5 bar) 0.8 MPa (8 bar) |
| MAXIMUM RECOMMENDED LOAD | Cotton, linen Synthetics Delicate fabrics Wool | 5 kg 2.5 kg 2.5 kg 2 kg |
| SPIN SPEED | Maximum | 1100 rpm ZWF 1111 W 1300 rpm ZWF 1311 W |
| CONSUMPTION DATA FOR WASHING 5 KG OF COTTONS with “ E60° ” PROGRAMME | Energy Water | 0.95 kWh 49 litres |



This appliance complies with the following E.E.C. Directives:

- 73/23 EEC of 19.2.73 (Low Voltage Directive) and subsequent modifications;
- 89/336 EEC of 3.5.89 (Electromagnetic Compatibility Directive) and subsequent modifications.

Unpacking

 The transport safeguard must be removed before putting the appliance into operation.

Important !

You are advised to keep all the packaging for re-use in case the machine is to be transported again.

- After removing all the packaging, with assistance carefully lay machine on it's back to remove the polystyrene base from the bottom.
- Remove the power supply cable and the draining hose from the hose holders on the rear of the appliance.

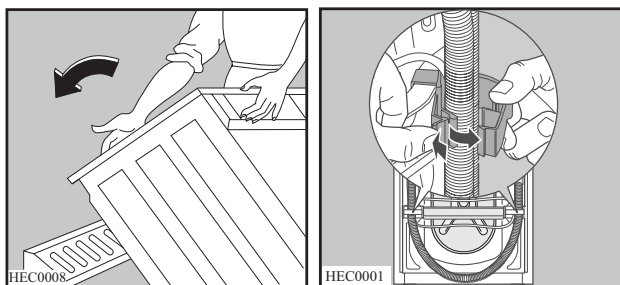

- With a suitable spanner unscrew and remove the central rear bolt **A**. Slide out the relevant plastic spacer.
- Unscrew and remove the two large rear bolts **B** and the six smaller bolts **C**.

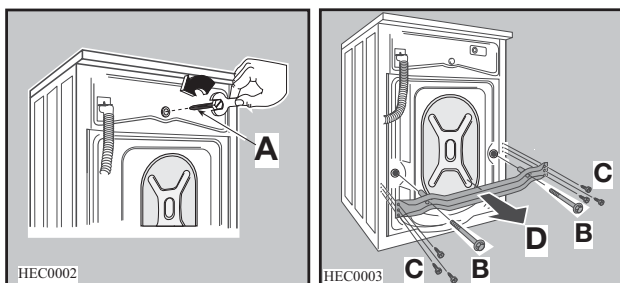

- Remove the bracket **D** and tighten up the six smaller bolts **C**.
- Open the porthole and remove the polystyrene block fitted with the adhesive tape on the door seal.

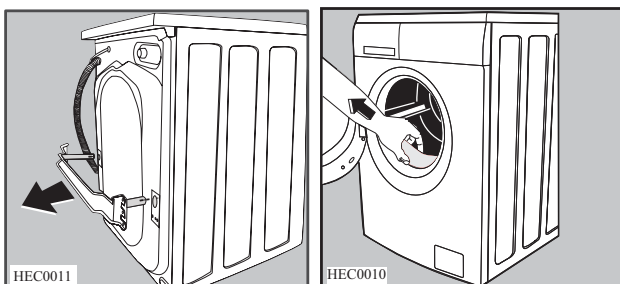

- Fill the smaller upper hole and the two large ones with the corresponding plastic plug caps supplied in the bag containing the instruction booklet.

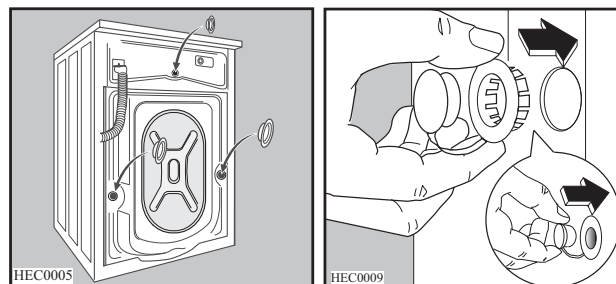

Important!

All the different plug caps are supplied with the appliance in the plastic bag containing the instruction booklet.

- Connect the water inlet hose as described under the paragraph "Water inlet".

Positioning

Install the machine on a flat hard floor.

Make sure that air circulation around the machine is not impeded by carpets, rugs etc. Check that the machine does not touch the wall or other kitchen units.

Never place cardboard, wood or similar materials under the machine to compensate for any unevenness in the floor.

Your new washing machine has been designed to be permanently plumbed in to your home's water supply and drainage system. However, if this is not possible, it may be connected to a suitable existing tap with the drain hose discharging into a sink.

The appliance has an inlet hose, with female 3/4" BSP thread connector. If this connection is not compatible with the plumbing of the existing installation, a variety of connectors are available from good hardware stores and plumbers merchants to suit most domestic plumbing. Any alteration to your existing plumbing must be carried out by a competent person, or qualified plumber.

Installation on a Suspended Floor

Suspended wooden floors are particularly susceptible to vibration. To help prevent vibration we recommend you place a waterproof wood panel, at least 15 mm thick under the appliance, secured to at least 2 floor beams with screws. If possible install the appliance in one of the corners of the room, where the floor is more stable.

Water inlet

An inlet hose is supplied and can be found inside the machine drum.

Do not use the hose from your previous machine to connect to the water supply.

1. Open the porthole and extract the inlet hose .
2. Connect the hose with the angled connection to the machine.

Important!

Do not place the inlet hose downwards. Angle the hose to the left or right depending on the position of your water tap.

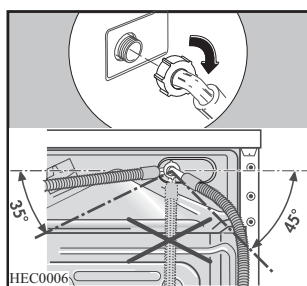

3. Set the hose correctly by loosening the ring nut. After positioning the inlet hose, be sure to tighten the ring nut again to prevent leaks.
4. Connect the hose to a tap with a 3/4" thread. Always use the hose supplied with the appliance.

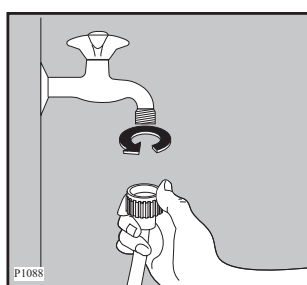

Installation should comply with local water authority and building regulations' requirements.

The appliance must be connected to a cold water supply.

A minimum water pressure of 0.05 MPa (0.5 bar) is required for safe operation of the appliance.

If you cannot make the cold water connection direct from the rising mains, you may be able to operate the appliance from your cold water storage system.

There should be a minimum distance of 5.02m (16.5 ft) between the appliance's inlet and the bottom of the water storage tank.

Water drainage

This appliance is designed to be permanently plumbed into your home's drainage system using one of the following methods.

1. Into a drainage standpipe.

Firstly form a hook in the end of the drain hose using the "U" piece supplied.

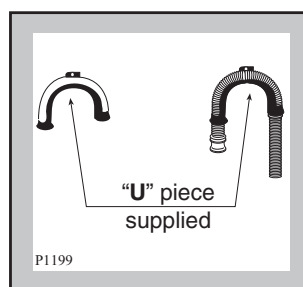

Place the drain hose into your standpipe, which should have an internal diameter of approximately 38mm thus ensuring there is an air break between the drain hose and standpipe.

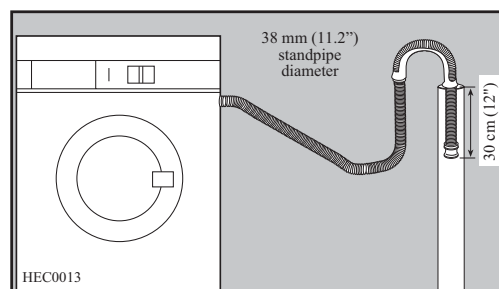

When discharging into a standpipe ensure that the top of the standpipe is no more than 90cm (35.4") and no less than 60cm (23.6") above floor level.

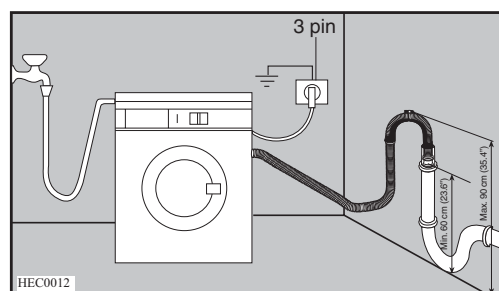

The drain hose may be extended to a maximum of 4 metres. An additional drain hose and joining piece is available from your local Service Force Centre. The joining piece must have an internal diameter of 18mm.

If your drain hose looks like this (see below) you do not require the “U” piece”. Just push the hose firmly into the standpipe.

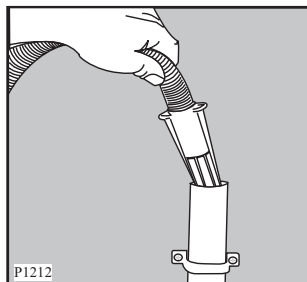

2. Onto a sink outlet spigot.

If the outlet spigot has not been used before, remove any blanking plug that may be in place.

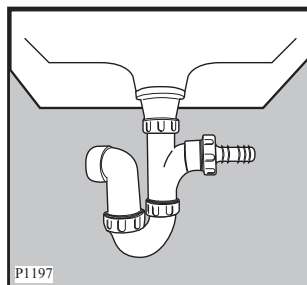

Push the drain hose onto the spigot and secure with a clip if required, ensure a loop is formed in the drain hose (see diagram) to prevent waste from the sink entering the washing machine.

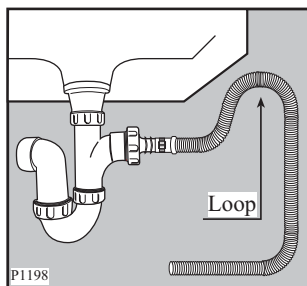

Important

- Before connecting the machine to new pipework or to pipework that has not been used for some time, run off a reasonable amount of water to flush out any debris that may have collected in the pipes.

Levelling

Level the washing machine by raising or lowering the feet. The feet may be tight to adjust as they incorporate a self locking nut, but the machine **MUST** be level and stable.

If necessary, check the setting with a spirit level.

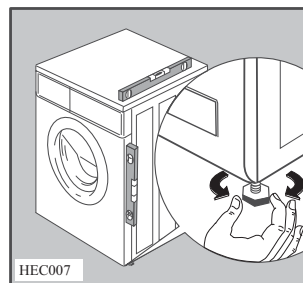

Any necessary adjustment can be made with a spanner. Accurate levelling prevents vibration, noise and displacement of the machine during operation.

Some vibration is inevitable, especially if mounted on a wooden floor.

Sprung wooden floors are particularly susceptible to vibration. For advice, consult a builder. If possible, always place the machine on a solid floor.

Special conditions

If the floor is carpeted or covered with crumbly or soft material, insert a rigid support base under the feet to prevent noise, vibration or displacement. The base should protrude a few centimetres beyond the edges of the machine.



Warning

The machine should **NOT** be placed on deep pile carpeting.

Note

Please ensure that when the appliance is installed it is easily accessible for the engineer in the event of a breakdown.

In the interest of the environment

Washing machines and dishwashers should be connected to the FOUL drainage system, the water will then be taken to a sewage works for treatment before being discharged safely into a river.

It is essential that these appliances are not connected to the surface water drainage system as this water is discharged directly into a river or stream and may cause pollution.

If you require any further advice please contact your local water authority.

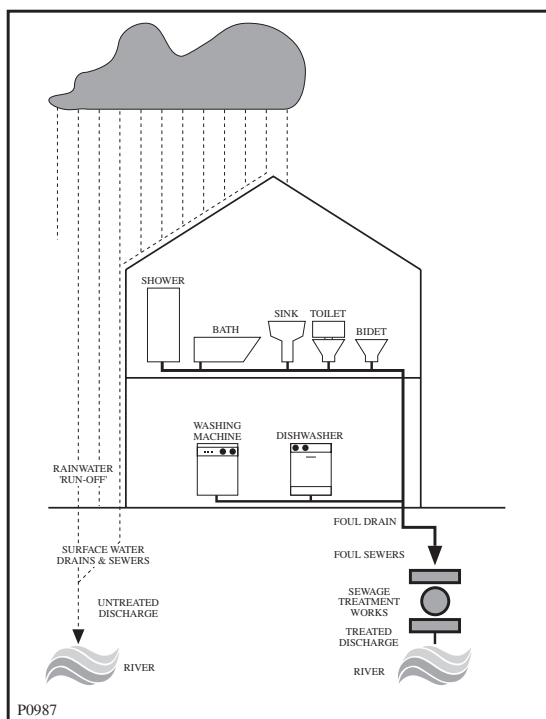

Should the plug need to be replaced for any reason, proceed as described below.

The wires in the mains lead are coloured in accordance with the following code:

- Green and Yellow - Earth
- Blue - Neutral
- Brown - Live

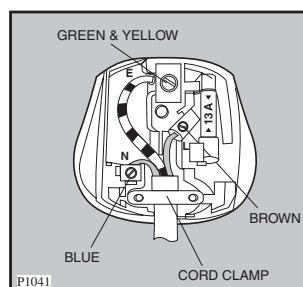

The wire coloured green and yellow must be connected to the terminal marked with the letter «E» or by the earth symbol \perp or coloured green and yellow.

The wire coloured blue must be connected to the terminal marked «N» or coloured black.

The wire coloured brown must be connected to the terminal marked «L» or coloured red.

Upon completion there must be no cut, or stray strands of wire present and the cord clamp must be secure over the outer sheath.

Electrical connection

Any electrical work required to install this appliance should be carried out by a qualified electrician or competent person.

WARNING: THIS APPLIANCE MUST BE EARTHED.
 The manufacturer declines any liability should this safety measure not be observed.

Before switching on, make sure the electricity supply voltage is the same as that indicated on the appliance's rating plate.

The rating plate is located at the top of the rim of the open door.

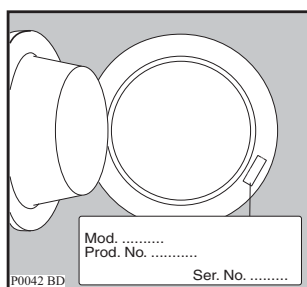

The appliance is supplied with a 13amp plug fitted. In the event of having to change the fuse in the plug supplied, a 13amp ASTA approved (BS1363/A) fuse must be used.

WARNING:
 A cut off plug inserted into a 13 amp socket is a serious safety (shock) hazard. Ensure that the cut off plug is disposed of safely. Should the appliance power supply cable need to be replaced, this must be carried out by our Service Force Centre.

The power supply cable must be easily accessible after installing the appliance.

Permanent connection

In the case of permanent connection it is necessary that you install a double pole switch between the appliance and the electricity supply (mains), with a minimum gap of 3mm between the switch contacts and of a type suitable for the required load in compliance with the current electrical regulations.

The switch must not break the yellow and green earth cable at any point.

 **From the Electrolux Group. The world's No. 1 choice.**

The Electrolux Group is the world's largest producer of powered appliances for kitchen, cleaning and outdoor use. More than 55 million Electrolux Group products (such as refrigerators, cookers, washing machines, vacuum cleaners, chain saws and lawn mowers) are sold each year to a value of approx. USD 14 billion in more than 150 countries around the world.